

TH412

Telehandler



**WACKER
NEUSON**
all it takes!



The compact multi-talent

Compact, maneuverable and powerful - the TH412 telehandler by Wacker Neuson is impressive in its combination of high lift height, lean width and strong machine performance. A true multi-talent, equipped for a broad spectrum of tasks and a wide variety of industry sectors.

- Lift height of 4.5 m in combination with a payload of 1.25 t
- Equipped with VLS (Vertical Lift System) for the highest productivity and safety
- The electronically regulated drive system enables tailored-to-suit machine operation.
- Economic engines of exhaust emissions stage V: 25 hp as standard and for more power, 45.3 hp (optional)
- All-wheel steering, front wheel steering and crab steering - three types of steering for maximum flexibility

TH412 Technical specifications

	Engine standard	Optional engine
Operating data		
Lift height mm	4,301	
Weight kg	2,750	2,900
Turning radius mm	2,695	
Engine / Motor		
Engine / Motor manufacturer	Yanmar	Yanmar
Engine / Motor type	3TNV80FT	3TNV86CHT
Engine performance kW	18.4	33.3
Displacement cm ³	1,226	1,568
Emission standards stage	V	V
Exhaust aftertreatment system	-	DOC/DPF
Specified sound pressure level LpA dB(A)	85	
Guaranteed sound power level LwA dB(A)	101	
Power transmission		
Traction drive	electronically regulated	
Speed (optional) km/h	0-20 (30)	
Speed Level	2	
Axles	PAL 1165	
Standard tires	10.0/75 - 15.3 AS	
Steering and operating hydraulics		
Steering angle max. °	2 x 38	
Flow rate (with 18.4 kW) l/min	28.6	
Flow rate (with 33.3 kW) l/min	41.6	
Pressure bar	220	
Kinematics		
Payload max. kg	1,250	
Payload at max. lift height kg	1,250	
Payload at max. reach kg	530	
Filling capacities		
Fuel tank capacity l	33	
Hydraulic oil tank l	36	

TH412 Dimensions

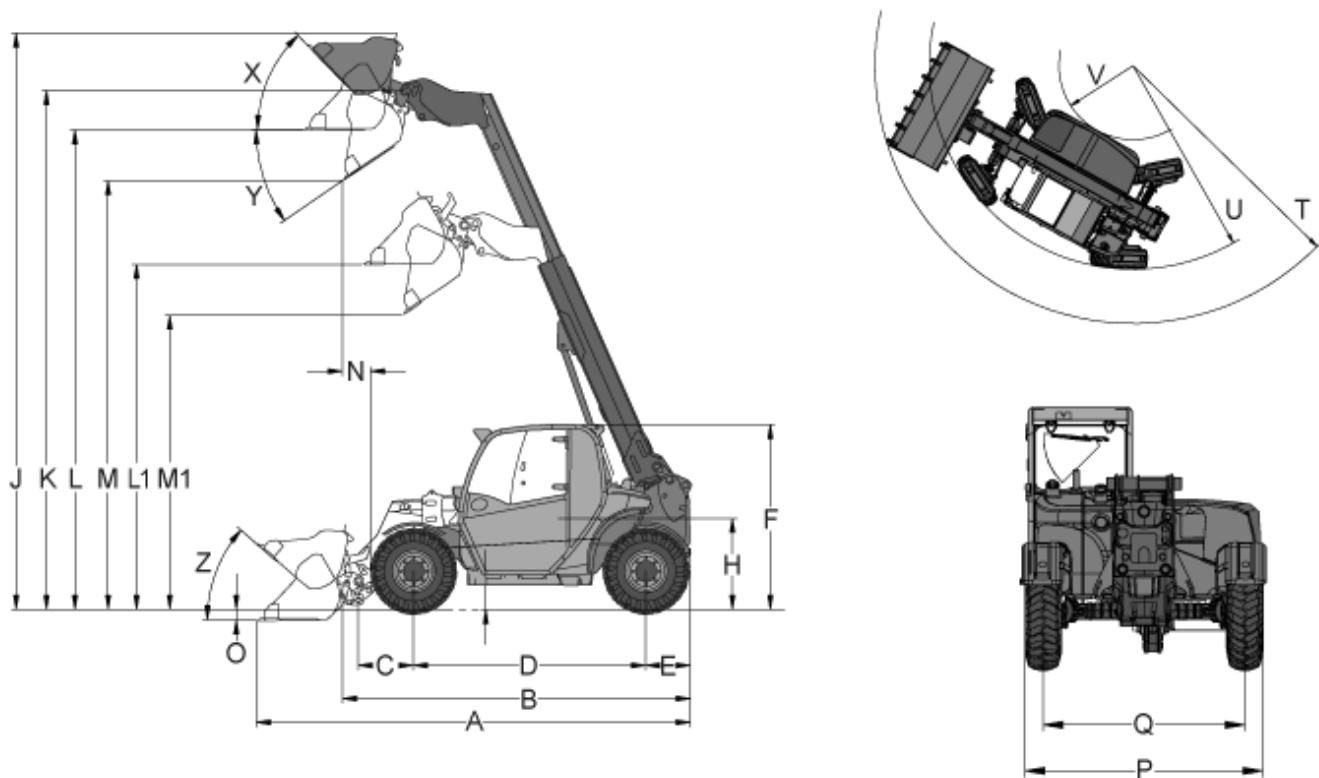

A	Overall length	3,944 mm
B	Overall length without bucket	2,977 mm
C	Bucket pivot point to axle center	450 mm
D	Wheelbase	1,922 mm
E	Rear overhang	427 mm
F	Height with cabin	1,995 mm
H	Seat height	978 mm
J	Total operating height	5,280 mm
K	Stroke height max. - bucket pivot point	4,537 mm
L1	Overhead loading height Telescopic arm retracted	2,949 mm
L	Overhead loading height Telescopic arm extended	4,163 mm
M1	Dump height max. Telescopic arm retracted	2,352 mm
M	Dump height max. Telescopic arm extended	3,566 mm
N	Range with M	476 mm
O	Scraping depth	96 mm
P	Overall width	1,564 mm
Q	Track width	1,235 mm
S	Ground clearance	294 mm
T	Radius (max.)	3,550 mm
U	Radius at outer edge	2,695 mm

V	Inside turning radius	951 mm
X	Bucket rollback at max. stroke height	53 °
Y	Dump angle (max.)	36 °
Z	Bucket rollback at ground level	36 °

Please note: that product availability can vary from country to country. It is possible that information / products may not be available in your country. More detailed information on engine power can be found in the operator's manual; the stated power may vary due to specific operating conditions. Subject to alterations and errors excepted. Applicable also to illustrations.

Copyright © 2021 Wacker Neuson SE.